

Infinity *Beta FifteenXdvc 15" Woofer – Technical Data*

SPECIFICATIONS

DIAMETER:	15" (381.0 mm)
SENSITIVITY (2.83V @ 1 m):	97 dB
POWER HANDLING:	350 Wrms
FREQUENCY RESPONSE:	18 ~ 350 Hz
NOMINAL IMPEDANCE:	4 OHMS (PER COIL)
VOICE-COIL DIAMETER:	3.18" (80.8 mm)

DIMENSIONS:

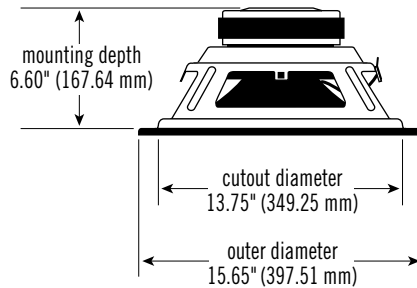

THIELE-SMALL PARAMETERS*

VOICE COIL DC RESISTANCE:	REVC (OHMS)	2.20
VOICE COIL INDUCTANCE @ 1 kHz:	LEVC (MH)	2.68
DRIVER RADIATING AREA:	SD (IN ²)	127.93
	SD (CM ²)	829.00
MOTOR FORCE FACTOR:	BL (TM)	13.97
	COMPLIANCE VOLUME:	VAS (FT ³)
	VAS (LITERS)	193.49
SUSPENSION COMPLIANCE:	CMS (μM/N)	198.27
MOVING MASS, AIR LOAD:	MMS (GRAMS)	173.96
MOVING MASS, DIAPHRAGM:	MMD (GRAMS)	160.24
FREE-AIR RESONANCE:	Fs (Hz)	27.10
MECHANICAL Q:	QMS	10.10
ELECTRICAL Q:	QES	0.33
TOTAL Q:	QTS	0.32
MAGNETIC-GAP HEIGHT:	HAG (IN)	0.35
	HAG (MM)	9.00
VOICE-COIL HEIGHT:	HVC (IN)	0.76
	HVC (MM)	19.40
MAXIMUM EXCURSION:	XMAX (IN)	0.20
	XMAX (MM)	5.20

*VOICE COILS CONNECTED IN PARALLEL

IMPEDANCE CURVE

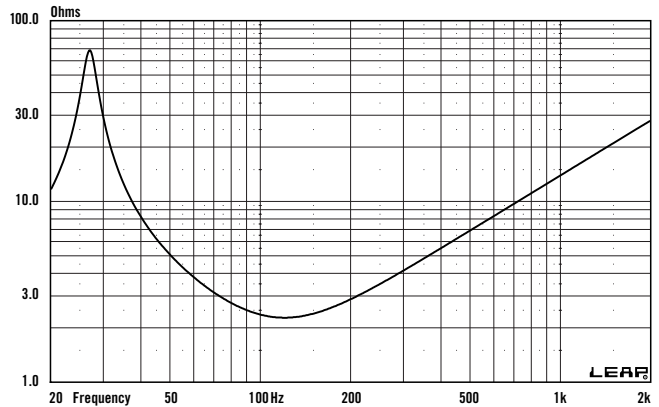

INFINITE BAFFLE FREQUENCY RESPONSE @ 2.83 V

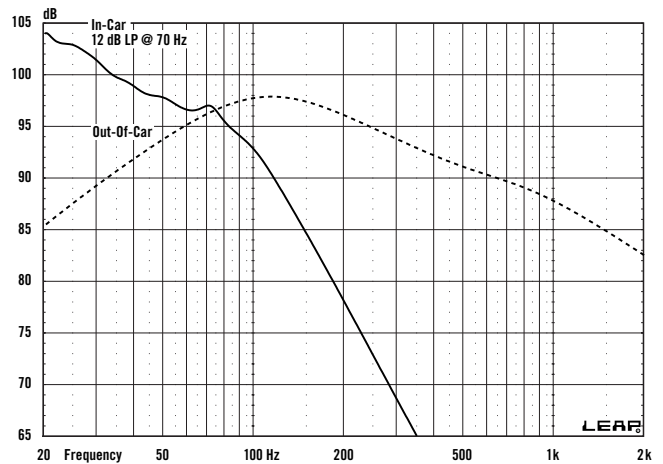

INFINITE BAFFLE EXCURSION/GROUP DELAY @ 150 W

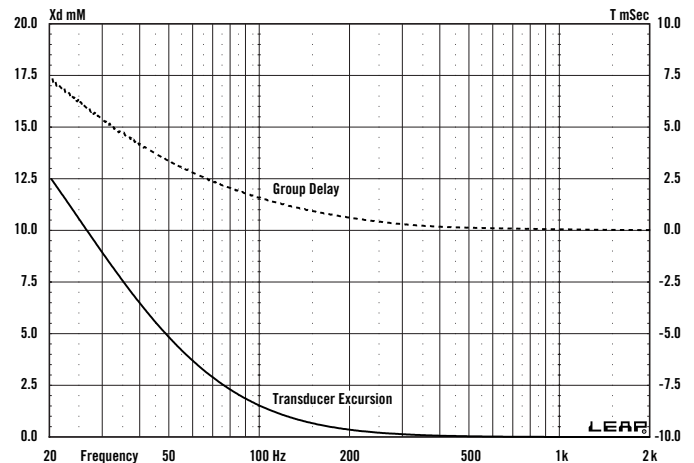

SEALED BOX VOLUME

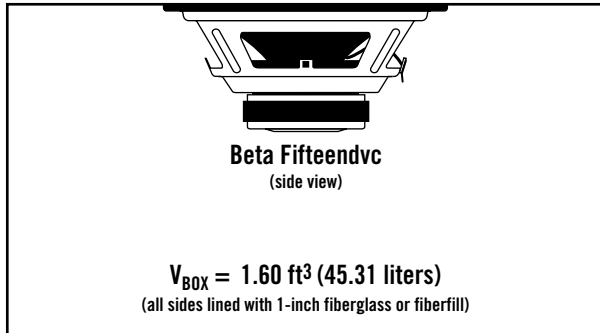

VENTED BOX VOLUME

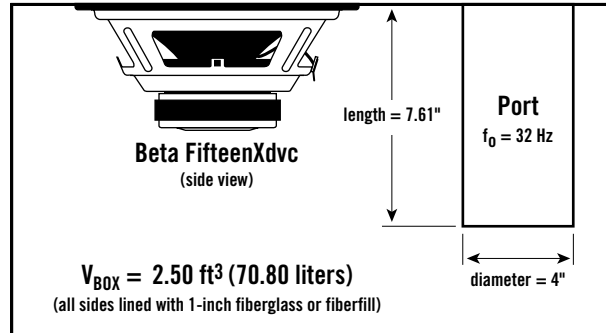

SEALED FREQUENCY RESPONSE @ 2.83 V

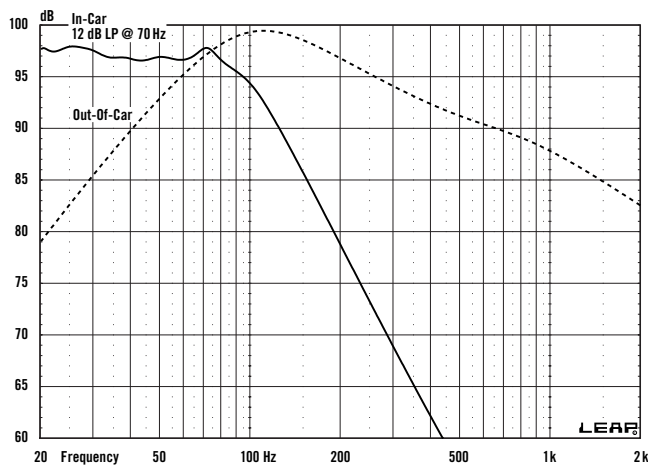

VENTED FREQUENCY RESPONSE @ 2.83 V

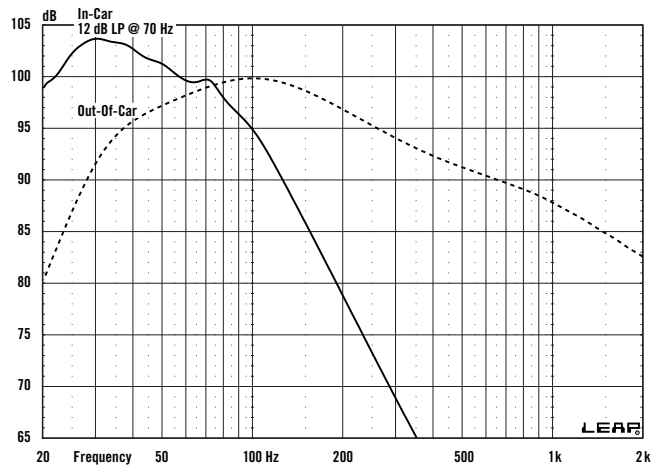

SEALED EXCURSION/GROUP DELAY @ 400 W

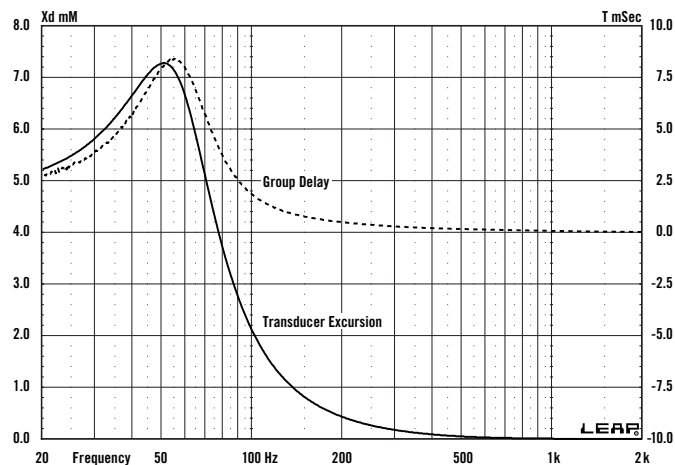

VENTED EXCURSION/GROUP DELAY @ 450 W

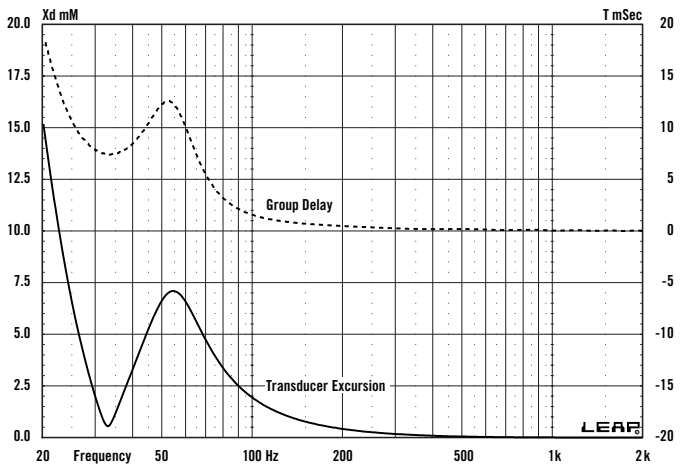

**SEALED BANDPASS
BOX VOLUME**

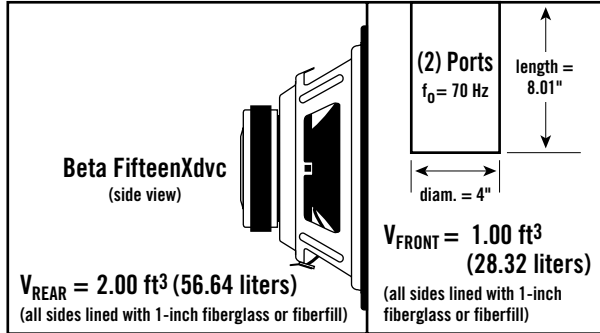

NOTES

**SEALED BANDPASS
FREQUENCY RESPONSE @ 2.83 V**

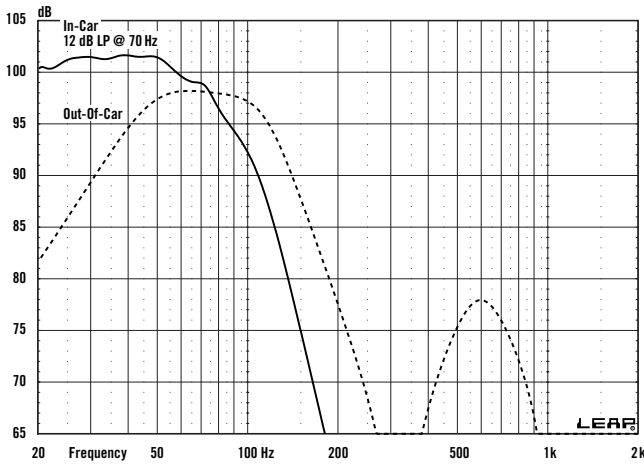

**SEALED BANDPASS
EXCURSION/GROUP DELAY @ 400 W**

